

RETURN INLET

Model	Code	Connection	Description	Flow Rate (L/min)
EM4408(A)	91601211	1" / 1.5" Class 6 Solvent	Return Inlet for Concrete Pool	50/150
EM4408(E)	91601212	32mm / 50mm PN6 Solvent	Return Inlet for Concrete Pool	50/150

1. For concrete pool
2. To glue into Metric $\phi 32$ mm
3. Imperial 1" solvent internal
4. Adjustable angle

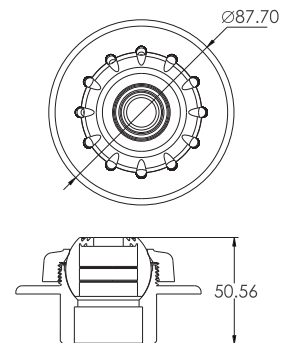

Model	Code	Connection	Description	Flow Rate (L/min)
EM4409(A)	91601213	1.5" / 2" Class 6 Solvent	Return Inlet for Concrete Pool	150/240
EM4409(E)	91601214	50mm / 63mm PN6 Solvent	Return Inlet for Concrete Pool	150/240

1. For concrete pool
2. To glue into Metric $\phi 50$ mm
3. Imperial 1.5" solvent internal
4. Adjustable angle

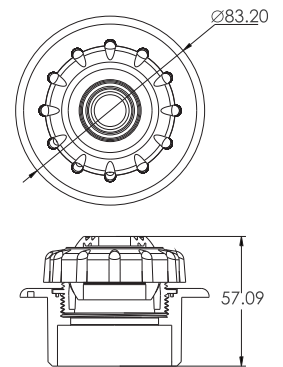

Model	Code	Connection	Description	Flow Rate (L/min)
EM4410(A)	91601215	1.5" Solvent, G2A Screwthread	Return Inlet for Concrete Pool	150
EM4410(E)	91601216	50mm Solvent, G2A Screwthread	Return Inlet for Concrete Pool	150

1. For concrete pool
2. Recommended wall conduit EM2841
3. G2A external thread
4. Metric $\phi 50$ mm solvent internal
5. Imperial 1.5" solvent internal
6. Adjustable angle

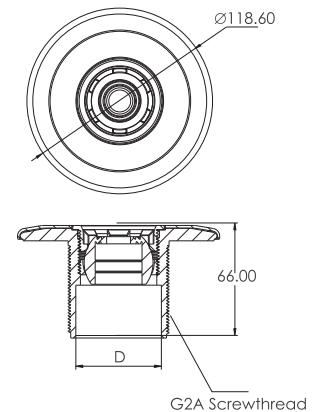

Model	Code	Connection	Description	Flow Rate (L/min)
EM4411(A)	91601217	1.5" Solvent, G2A Screwthread	Return Inlet for Concrete Pool	150
EM4411(E)	91601218	50mm Solvent, G2A Screwthread	Return Inlet for Concrete Pool	150

1. For concrete pool
2. Recommended wall conduit EM2841
3. G2A external thread
4. Metric $\phi 50$ mm solvent internal
5. Imperial 1.5" solvent internal
6. Adjustable angle

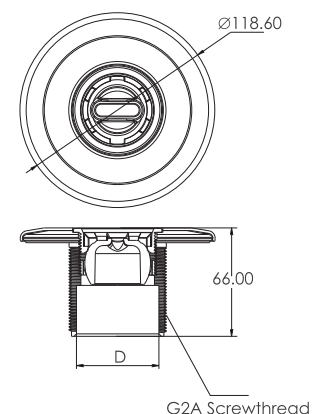

RETURN INLET

Model	Code	Connection	Description	Flow Rate (L/min)
EM4412(A)	91601219	1.5" Solvent, G2A Screwthread	Return Inlet for Vinyl and Liner Pool	150
EM4412(E)	91601220	50mm Solvent, G2A Screwthread	Return Inlet for Vinyl and Liner Pool	150

1. For vinyl pool and liner pool
2. G2A external thread
3. Metric ϕ 50mm solvent internal
4. Recommended wall conduit EM2842
5. Imperial 1.5" solvent internal
6. Adjustable angle

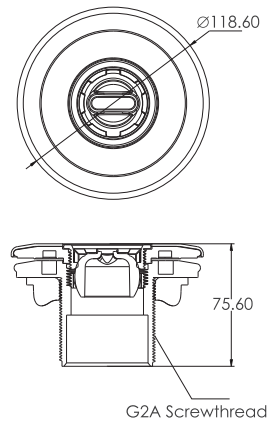

Model	Code	Connection	Description	Flow Rate (L/min)
EM4413(A)	91601221	1.5" / 2" Class 12 Solvent	Return Inlet for Concrete Pool	150
EM4413(E)	91601222	50mm / 63mm PN10 Solvent	Return Inlet for Concrete Pool	150

1. For concrete pool
2. To glue into Metric ϕ 50mm or 63mm PN10
3. Imperial 1.5" solvent internal
4. To glue into Imperial 2" Class 12 pipe
5. Adjustable angle

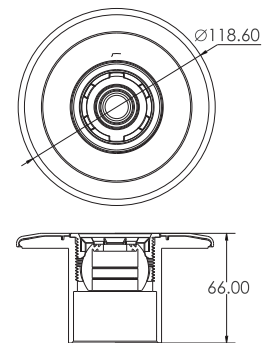

Model	Code	Connection	Description	Flow Rate (L/min)
EM4414(A)	91601223	1.5" Solvent, G2A Screwthread	Return Inlet for Vinyl and Liner Pool	150
EM4414(E)	91601224	50mm Solvent, G2A Screwthread	Return Inlet for Vinyl and Liner Pool	150

1. For vinyl pool and liner pool
2. G2A external thread
3. Metric ϕ 50mm solvent internal
4. Recommended wall conduit EM2842
5. Imperial 1.5" solvent internal
6. Adjustable angle

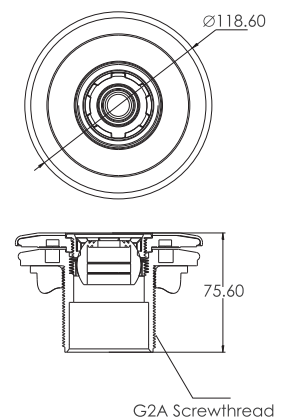

Model	Code	Connection	Description	Flow Rate (L/min)
EM4415(A)	91601225	1.5" Solvent, G2A Screwthread	Return Inlet for Vinyl and Liner Pool	150
EM4415(E)	91601226	50mm Solvent, G2A Screwthread	Return Inlet for Vinyl and Liner Pool	150

1. For vinyl pool and liner pool
2. G2A external thread
3. Metric ϕ 50mm solvent internal
4. Recommended wall conduit EM2842
5. Imperial 1.5" solvent internal
6. Adjustable angle

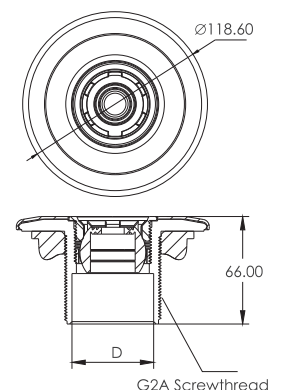

FLOOR INLET

Model	Code	Connection	Description	Flow Rate (L/min)
EM2861(A)	91600819	2" Class 12 Solvent	Floor Inlet for Concrete Pool	200
EM2861(E)	91600820	63mm PN10 Solvent	Floor Inlet for Concrete Pool	200

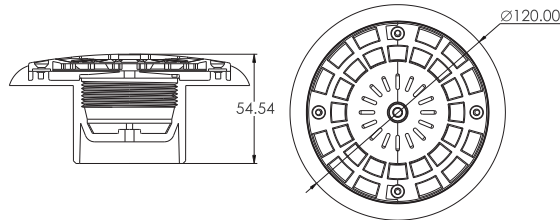

Model	Code	Connection	Description	Flow Rate (L/min)
EM2862(A)	91600821	1.5" Solvent, G2A Screwthread	Floor Inlet for Concrete Pool	200
EM2862(E)	91600822	GB50 Solvent, G2A Screwthread	Floor Inlet for Concrete Pool	200

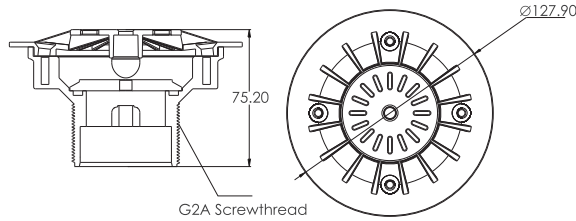

Model	Code	Connection	Description	Flow Rate (L/min)
EM2863(A)	91600823	1.5" Solvent, G2A Screwthread	Floor Inlet for Vinyl and Liner Pool	200
EM2863(E)	91600824	GB50 Solvent, G2A Screwthread	Floor Inlet for Vinyl and Liner Pool	200

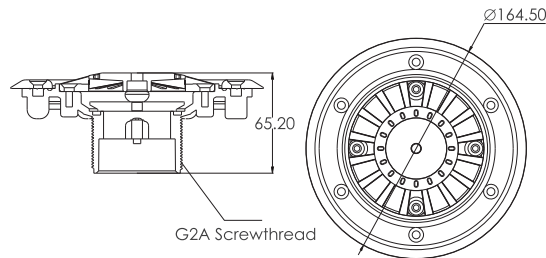

Model	Code	Connection	Description	Flow Rate (L/min)
EM2817V(A1)	91600520	1.5" Solvent	Floor Inlet for Vinyl and Liner Pool (Imperial)	150
EM2817V(A2)	91600521	2" Solvent	Floor Inlet for Vinyl and Liner Pool (Imperial)	240
EM2817C(A1)	91600518	1.5" Solvent	Floor Inlet for Concrete Pool (Imperial)	150
EM2817C(A2)	91600519	2" Solvent	Floor Inlet for Concrete Pool (Imperial)	240
EM2817C(E1)	91600524	50mm Solvent	Floor Inlet for Concrete Pool (Metric)	150
EM2817C(E2)	91600525	63mm Solvent	Floor Inlet for Concrete Pool (Metric)	240

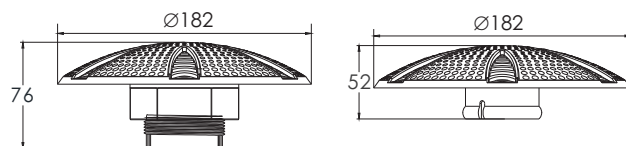

EM2817V(A1)
EM2817V(A2)

EM2817C(A1) / EM2817C(A2)
EM2817C(E1) / EM2817C(E2)



SUCTION FITTING, VACUUM AND OUTLET FITTING

Model	Code	Description	Flow Rate (L/min)
EM2822	91601501	Suction Fitting	150

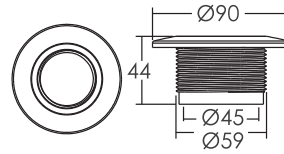

Model	Code	Description	Flow Rate (L/min)
EM2822A	91601502	Cover of Suction Fitting	115
EM2822B	91601503	Cover of Suction Fitting	115

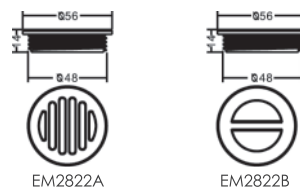

Model	Code	Connection	Description	Flow Rate (L/min)
EM2827C(A)	91601504	1.5"	Vacuum Fitting for Concrete Pool (Imperial)	150
EM2827C(E)	91601506	50mm	Vacuum Fitting for Concrete Pool (Metric)	150

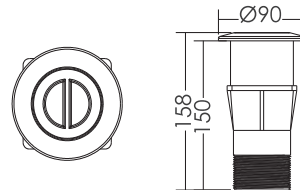

Model	Code	Connection	Description	Flow Rate (L/min)
EM2827V(A)	91601505	1.5"	Vacuum Fitting for Vinyl Pool (Imperial)	150
EM2827V(E)	91601507	50mm	Vacuum Fitting for Vinyl Pool (Metric)	150

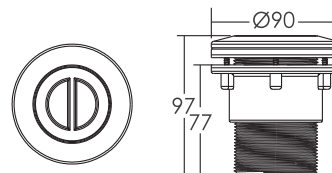

Model	Code	Connection	Description	Flow Rate (L/min)
EM2828C(A)	91601201	1.5"	Outlet Fitting for Concrete Pool (Imperial)	69
EM2828C(E)	91601203	50mm	Outlet Fitting for Concrete Pool (Metric)	69

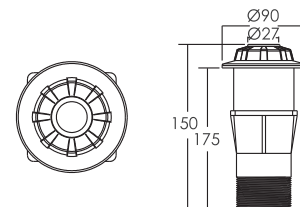

Model	Code	Connection	Description	Flow Rate (L/min)
EM2828V(A)	91601202	1.5"	Outlet Fitting for Vinyl Pool (Imperial)	69
EM2828V(E)	91601204	50mm	Outlet Fitting for Vinyl Pool (Metric)	69

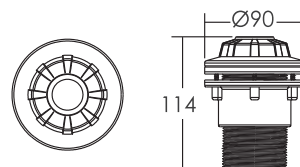

WALL RETURN AND GUTTER DRAIN

Model	Code	Connection	Description	Flow Rate (L/min)
EM2819 (A1)	91600801	1.25" Solvent	Gutter Drain (Imperial)	92
EM2819 (A2)	91600802	1.5" Solvent	Gutter Drain (Imperial)	150
EM2819 (A3)	91600803	2" Solvent	Gutter Drain (Imperial)	240
EM2819 (E1)	91600804	50mm Solvent	Gutter Drain (Metric)	150
EM2819 (E2)	91600805	63mm Solvent	Gutter Drain (Metric)	240

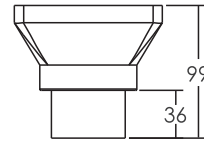
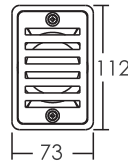

Model	Code	Connection	Description	Flow Rate (L/min)
EM2824 (A1)	91600806	1.25" Solvent	Wall Return (Imperial)	92
EM2824 (A2)	91600807	1.5" Solvent	Wall Return (Imperial)	150
EM2824 (A3)	91600808	2" Solvent	Wall Return (Imperial)	240
EM2824 (E1)	91600809	50mm Solvent	Wall Return (Metric)	150
EM2824 (E2)	91600810	63mm Solvent	Wall Return (Metric)	240

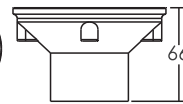
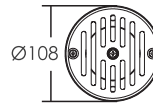

Model	Code	Connection	Description	Flow Rate (L/min)
EM2825 (A1)	91600811	1.25" Solvent	Wall Return (Imperial)	92
EM2825 (A2)	91600813	1.5" Solvent	Wall Return (Imperial)	150
EM2825 (A3)	91600812	2" Solvent	Wall Return (Imperial)	240
EM2825 (E1)	91600814	50mm Solvent	Wall Return (Metric)	150
EM2825 (E2)	91600815	63mm Solvent	Wall Return (Metric)	240

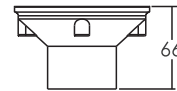
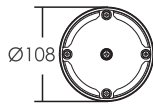

Model	Code	Connection	Description	Flow Rate (L/min)
EM2826(A1)	91600816	1.5" Solvent	Wall Return (Imperial)	122
EM2826(A2)	91600817	2" Solvent	Wall Return (Imperial)	200
EM2826(E1)	91600818	50mm Solvent	Wall Return (Metric)	150

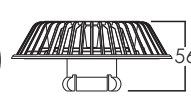
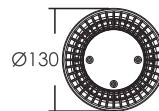

Model	Code	Description	Flow Rate (L/min)
EM2510	91600401	Hydrostatic Valve	150-240

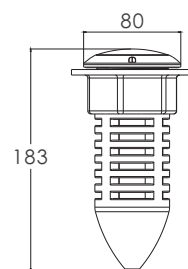
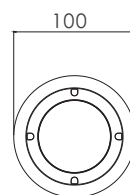

VACUUM AND CONDUIT

Model	Code	Connection	Description	Flow Rate (L/min)
EM2831(A)	91601508	1.5" Solvent, G2A Screwthread	Vacuum (Imperial)	150-240
EM2831(E)	91601509	50mm Solvent, G2A Screwthread	Vacuum (Metric)	150-240

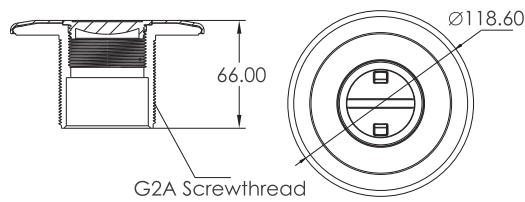

Model	Code	Connection	Description	Flow Rate (L/min)
EM2836A	91601510	1.5" Solvent, G2A Screwthread	Vacuum (Imperial)	150-240
EM2836E	91601511	50mm Solvent, G2A Screwthread	Vacuum (Metric)	150-240

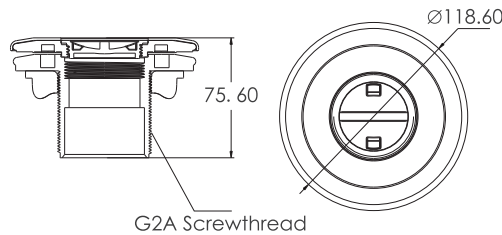

Model	Code	Connection	Description	Flow Rate (L/min)
EM2841	91602501	1.5" / 50mm Solvent, G2A Screwthread	Conduit for Concrete Pool	150-240

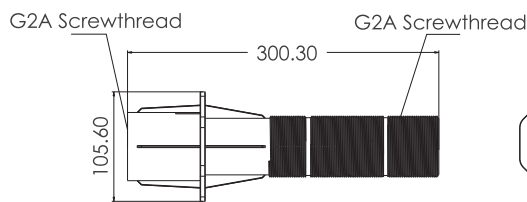

Model	Code	Connection	Description	Flow Rate (L/min)
EM2842	91602502	1.5" / 50mm Solvent, G2A Screwthread	Conduit for Vinyl and Liner Pool	150-240

