

PART LIST

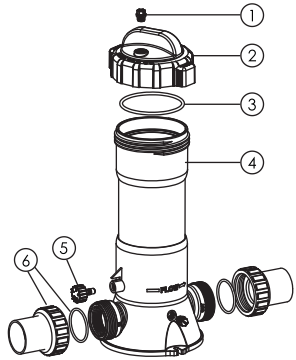

CL-01/CL-02 Part List			
Key No.	Part No.	Description	Qty
1	89440312	Air / Water Release Valve with O-Ring	2
2	89440204	Lid with Nut	1
3	02080008	O-Ring for Lid	1
4	89440205	CL-01A Feeder Body	1
4	89440206	CL-02A Feeder Body	1
5	89440202	Hose with O-Ring	1
6	89440201	1.5"Union with Nut	2

CL-01A/CL-02A Part List			
Key No.	Part No.	Description	Qty
1	89440312	Air / Water Release Valve with O-Ring	2
2	89440204	Lid with Nut	1
3	02080008	O-Ring for Lid	1
4	89440205	CL-01A Feeder Body	1
4	89440206	CL-02A Feeder Body	1
5	89440202	Hose with O-Ring	1
6	89440203	Threaded Plug	2
7	89440208	Hose Connector	2
8	01093017	2.5m Hose (O.DΦ10)	1
9	89440207	Saddle Fitting Adaptor	2
10	03018153	Hose Clamp	2

SADDLE CLAMP ASSEMBLY

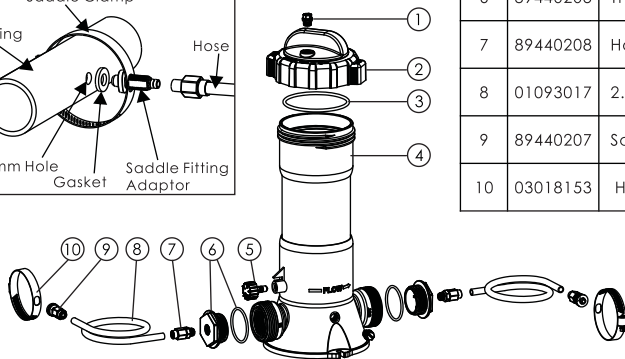
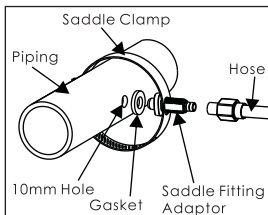

EMAUX CL Series Automatic Chlorine Feeder

Keep the manual for future reference

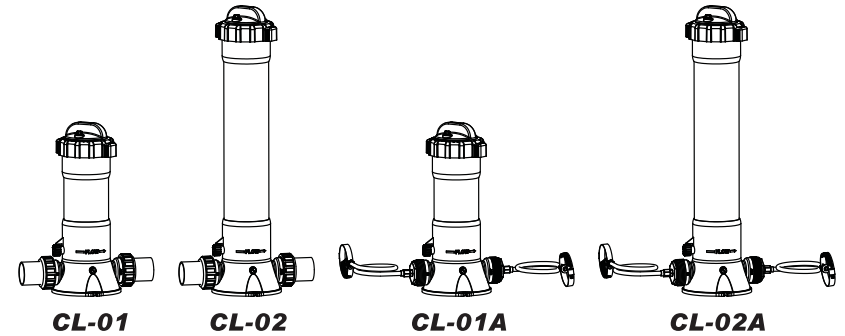

EMAUX CL series automatic chlorine feeder is designed to be used side by side with your filtration system. The feeder is driven by the pressure difference between its outlet and inlet which pushes water through it. It uses slow-dissolve Trichloro-S-Triazinetrione (Tri-Chlor) large or small tablets (or sticks) ONLY. You should NEVER use other type of chemical. CL-01 and CL-01A can hold up to 2kg of tablets while CL-02 and CL-02A can hold up to 4kg. Such capacity should be able to provide 1 to 2 weeks' chlorination for large pools. The feeder has a dial type control valve to adjust the flow rate through itself, by regulating the valve setting and the amount of Tri-Chlor tablets placed in the feeder, the chlorine feed rate needed to maintain the proper chlorine level of your pool can be readily tuned.

⚠ WARNING: READ CAREFULLY AND KEEP THE MANUAL FOR FUTURE REFERENCE

This feeder can ONLY be used with slow-dissolving Tri-Chlor. Do NOT mix with other type of chlorine or chemical, otherwise it may cause explosion or fire.

Great care must be taken while opening the feeder. Always switch off pump and close all available valves before opening. Do NOT inhale air from any chemical feeder or container. Always protect your eyes, skin and clothing from any chemical.

Do NOT open a feeder while the pump is running.

To prevent gas from building up in the feeder, make sure the pool return line valve is kept open-except when opening or servicing. Always read the labels warning information and closely follow chlorine manufacture's and or dealer's recommendation for proper conditioning and daily chlorine requirements for your particular pool.

DIRECTIONS FOR USE

- 1) Before starting up your chlorine feeder your pool/spa should be properly conditioned with a chlorine level of 1.0 to 1.5ppm. Directions and instructions from dealer and chemical manufacturer should be followed.
- 2) The chlorine demand for pools and spas varies according to load, usage, temperature, sunlight etc. Initially you should experiment to determine the proper amount of chlorine and the correct valve setting required for our pool and filter time cycle. Taking a 90 cubic meter pool as a reference, we suggest You place about 1.8kg slow dissolve Tri-Chlor tablets in your feeder and leave the dial valve setting at No.3.(Increase or reduce the chlorine amount basing on the pool size, for example, for 135 cubic meter pool add 50% more chlorine.) Check chlorine residual daily

and adjust the dial valve for more or less chlorine. Increasing the quantity of chlorine in your feeder with extend the recharging circle.

OPENING THE FEEDER LID

- 1) Turn off pump and turn Dial Control Valve to "O". Shut off inline valve(s) if any to prevent backflow. Unscrew Venting Screw at the top of the Lid. Wait for 1 minute to ensure the release of pressure.
- 2) Turn the Nut of the Lid anti-clockwise to disassemble the Lid.

CLOSING THE FEEDER LID

- 1) Align the Nut of the Lid to the threads of the Feeder. Engage the Nut threads by turning clockwise to tighten.
- 2) Tighten the Venting Screw.
- 3) Set the Dial Control Valve to the desired position then open the inline valve(s) if available.
- 4) Turn on pump.

VACUUMING

Close Dial Control Valve to avoid bypass of sediment and possible clogging of control valve when vacuuming.

CHANGING O-RINGS

- 1) Follow the steps under "OPENING THE FEEDER LID"
- 2) Before replacing the o-ring, make sure all liquid has been discharged by removing the Feeder's bottom drain plug with a screwdriver.
- 3) Turn the Lid upside down and the o-ring can be found.
- 4) Insert a flat head screwdriver into the groove as indicated. Using the screwdriver at an angle lift the o-ring.
- 5) Once the o-ring had been replaced. Follow the steps under "CLOSING THE FEEDER LID".
- 6) Turn the Dial Control Valve to maximum setting and continue to turn anti-clockwise until the dial control click twice. The Drain Control Valve can then be removed from the feeder.
- 7) Replace the two o-rings.
- 8) Once the o-rings had been replaced, insert the Dial Control Valve back into the feeder. Turn clockwise until the Dial Control click twice. It is important to ensure the Dial Control passes the second click.
- 9) Select the desired position then open inline valve and restart the pump.

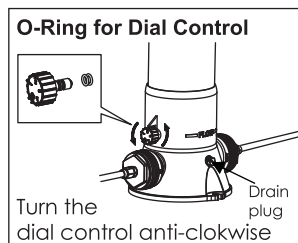
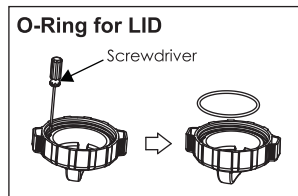

WARNING: DO NOT use petroleum type of lubricants or the o-ring; Vaseline is recommended.

INSTALLATION

HARD PIPE (CL-01 / CL-02)

Position the Chlorine Feeder on level surface as close to the filter and pump as possible. The preferred installation is above water level and using Inline Setup (Figure 1). The feeder needs to be below the filter or the heater (if available) as indicated in Figure 1. Offline Setup is also possible by installing the feeder inlet to the pump outlet and feeder outlet behind the heater outlet as indicated in Figure 2. If no heater, connection will be made after the filter.

Figure 1

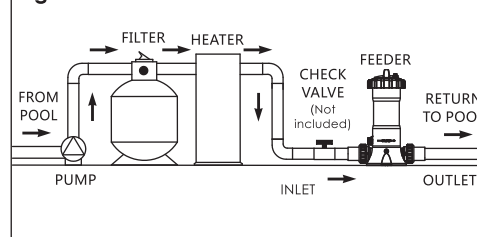
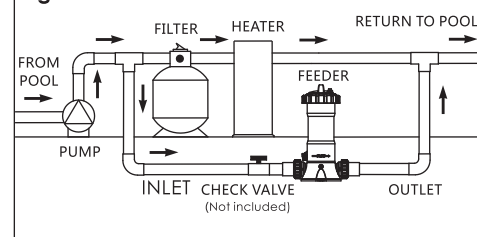

Figure 2



At the inlet pipe to the feeder, a positive seal corrosion-resistant check valve should be installed to reduce backflow of chlorine gas when the system is turned off. It is recommended that if the feeder is installed below the waterline, a check valve is needed to prevent water backflow when opening the unit.

FLEXIBLE HOSE (CL-01A / CL-02A)

The Stainless Steel Saddle Clamps for the Flexible Hose installation are designed for pipes with diameter of 1.5' or 2.0'.

Figure 3

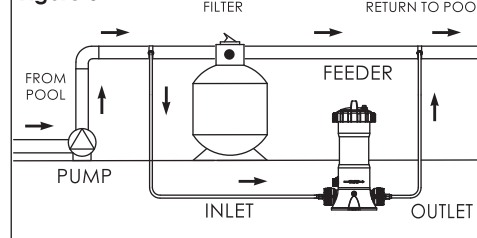
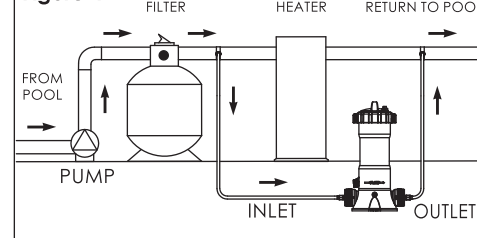
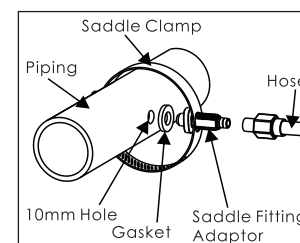

Figure 4



Inlet

- 1) Along the pipe between the pump and the filter as shown in Figure 3, make a hole of 10mm in diameter as the inlet for the feeder.
- 2) Clean off burrs and shavings, insert the Saddle Fitting Adaptor with Gasket into the drilled hole. Place the Saddle Clamp on to the pipe as indicated. Connect the hose.



Outlet

- 3) Along the pipe after the filter as shown in figure 3 and after heater if installed figure 4, drill a hole of 10mm in diameter as the outlet for the feeder.
- 4) Clean off burrs and shavings, insert the Saddle Fitting Adaptor with Gasket into the drilled hole. Place the Saddle Clamp on to the pipe as indicated. Connect the hose.
- 5) Connect the inlet and outlet tubing with the Adaptor into the Feeders' Threaded Plug.

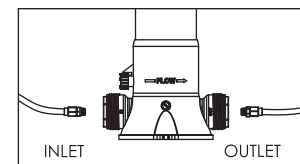

Note: After installation start up the system to perform leakage check, retighten if required. The feeder can be fixed onto the installation surface by tapping screws and securing holes in its base.

EMAUX CLL Series Automatic Chlorine Feeder

Keep the manual for future reference

EMAUX CLL series automatic chlorine feeder is designed to be used side by side with your filtration system. The feeder is driven by the pressure difference between its outlet and inlet which pushes water through it. It uses slow-dissolve Trichloro-S-Triazinetrione (Tri-Chlor) large or small tablets (or sticks) only. You should NEVER use other type of chemical. CLL50 can hold up to 6kg of tablets while CLL75 can hold up to 11kg. Such capacity should be able to provide 3 to 6 weeks' chlorination for large pools. The feeder has a true union ball valve to adjust the flow rate through itself, by regulating the valve setting and the amount of Tri-Chlor tablets placed in the feeder, the chlorine feed rate needed to maintain the proper chlorine level of your pool can be readily tuned.

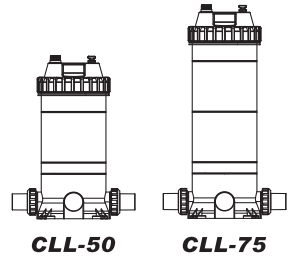

READ CAREFULLY AND KEEP THE MANUAL FOR FUTURE REFERENCE.

WARNING:

This feeder can ONLY be used with slow-dissolving Tri-Chlor. DO NOT mix with other type of chlorine or chemicals, otherwise it may cause explosion or fire.

Great care must be taken while opening the feeder. Always switch off pump and close all available valves before opening. Do not inhale fume from any chemical feeder or container.

Always protect your eyes, skin and clothing from any chemical.

DO NOT open a feeder while the pump is running.

To prevent gas from building up in the feeder, make sure the pool return line valve is kept open except when opening or servicing. Always read the labels, warning information and closely follow chlorine manufacturer's and or dealer's recommendation for proper conditioning and daily chlorine requirements for your particular pool and area.

DIRECTIONS FOR USE

Before starting up your chlorine feeder your pool/spa should be properly conditioned with a chlorine level of 1.0 to 1.5ppm. Directions and instructions from dealer chemical manufacturer and dealer should be followed.

The chlorine demand for pools and spas varies according to load, usage, temperature, sunlight etc. Initially you should experiment to determine the proper amount of chlorine and the correct check valve setting required for our pool and filter time cycle. Check chlorine residual daily and adjust the dial valve for more or less chlorine. Increasing the quantity of chlorine in your feeder will extend the recharging cycle.

OPENING THE FEEDER LID

- 1) Turn off the pump and close off inline check valve if any to prevent backflow; unscrew Air Release Valve on the Lid and wait for 1 minute.
- 2) Turn the Ring Lock of the Lid anti-clockwise to open the Lid.

 **Caution: DO NOT inhale the gas from the feeder.**

CLOSING THE FEEDER LID

- 1) Ensure the o-ring is properly placed to the Lid, align the Lid to the Cartridge Filter Body.
- 2) Engage thread with the Ring Lock and turn clockwise to tighten.
- 3) Tighten Air Release Valve.
- 4) Set the check valve (not included) to the desired position then open inlet valve (if available).
- 5) Restart pump.

VACUUMING

Close check valve (not included) to avoid bypass of sediment and possible clogging of control valve when vacuuming.

CHANGE O-RING

- 1) The steps under "OPENING THE FEEDER LID".

- 2) Before replacing O-ring make sure the all liquid has been discharged (by removing the bottom drain plug).
- 3) Replace the o-ring and lubricate the surface of the o-ring before closing the Lid.
- 4) Fasten the bottom drain plug.
- 5) Follow the steps under "CLOSING THE FEEDER LID".

Warning: DO NOT use petroleum type of lubricants on the O-ring; Vaseline is recommended

WINTERIZING

When cold weather is forthcoming, drain all water in the feeder by loosening the Bottom Drain Plug. Open the feeder lid and with chemical resistant gloves on carefully take out the undissolved tablets and rinse the feeder thoroughly with water then put the cover back.

INSTALLATION

Position the chlorinator on level surface as close to the filter and pump as possible. The preferred installation is above water level and below filter or heater outlet (Figure 1); or is offline with feeder inlet connecting to the pump outlet and feeder outlet behind the heater outlet.

An inline positive seal corrosion-resistant check valve is to be installed to reduce backflow of chlorine gas when the system is shut off and to control the follow of water to the feeder. If the chlorine feeder must be located below water level, a check valve is needed to prevent water backflow when opening the unit as well as to control the flow of water.

The CLL series feeders feature with two inlets, either one can be chosen to meet the installation requirements and seal the other with the supplied plug and PVC glue.

Note: After installation start up the system to perform leakage check, re-tighten if required. This installation can only apply to imperial/metric 1.5" pipes. The feeder can be fixed onto the installation surface by tapping screws and 4 securing holes in its base.

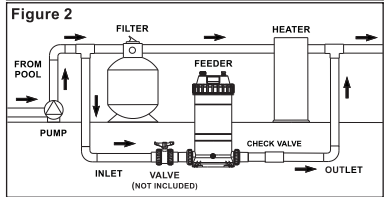
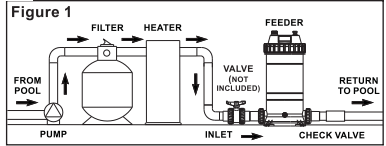

CLL-50 / CLL-75 PART LIST			
Key No.	Part No.	Description	Qty
1	89440309	Drain Plug with O-Ring	1
2	89440313	Connector for Pressure Gauge/Stopper with O-Ring (Viton)	1
3	89440310	Air Release Valve with O-Ring	1
4	01021006	Ring Lock for Cartridge Filter	1
5	01011020	Lid	1
6	02080003	O-Ring for Lid	1
7	89440301	CLL-50 Diffuser Assembly	1
7	89440302	CLL-75 Diffuser Assembly	1
8	89440311	1.5" Union	2
9	89440303	CLL-50 Feeder Body	1
9	89440304	CLL-75 Feeder Body	1
10	01011015	Plug	1
11	89440312	Air/Water Release Valve with O'Ring	1