

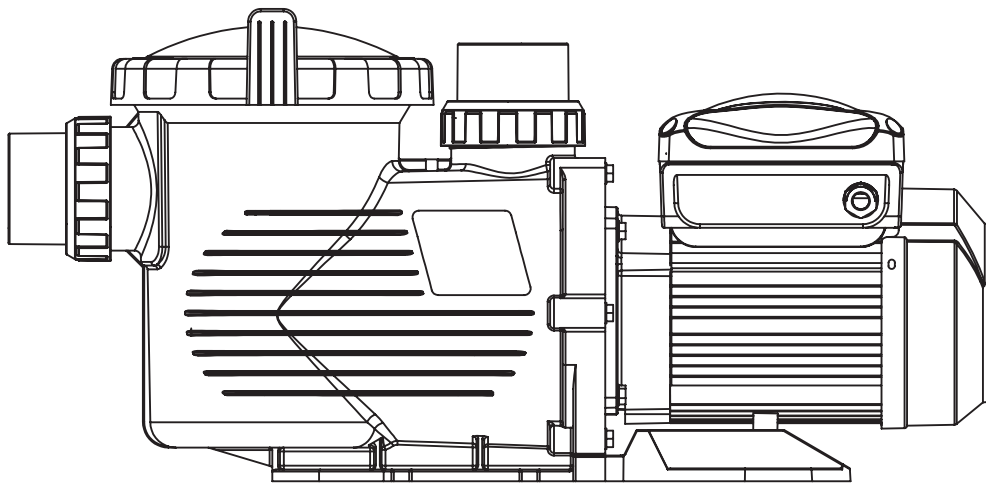

EPV Series Pump Installation & Operating Instructions



1.Pump Installation

- Please install on a level vibration free surface.
- Allow use of short, direct suction pipe. (To reduce friction losses & don't install the pump at more than 3M geometrical height from water level)
- Allow for gate valves in suction and discharge piping if required.
- Have adequate floor drainage to prevent flooding.
- Protect from excess moisture.
- Allow the adequate access for servicing pump and piping.

NOTICE:

Pump suction and discharge connections have molded in thread stops, DO NOT try to screw pipe in beyond these stops.

1.1 Operation

The pump is fitted with a wide range of settings to suit any filtration requirements. The controller is used to program a range of Motor speeds and settings described as "Schedules" in the program. To program the pump go to page 6 for easy description of how this is done. **NEVER** run pump dry! Running pump dry may damage seals, causing leakage and flooding! Fill pump with water before starting Motor.

- Before removing lid:
- STOP PUMP before proceeding.
- RELEASE ALL PRESSURE from pump and piping system.
- NEVER tighten or loosen screws while pump is operation.
- Do not block pump suction!

1.2 Priming Pump:

- Release all air from filter and piping system: see filter owner manual.
- In a flooded suction system (water source higher than pump), pump will prime itself when suction and discharge valves are opened.
- If pump is not in a flooded suction system, unscrew and remove pump lid and fill with water.

NOTICE: Tighten pump lid by hand only.

1.3 Main Power Wiring Instruction

- This is the alternative option for owner who would like to wire the main power to EPV Series Pump.
- There are two terminals label AC-L and AC-N. Attach the power leads to these terminals.
- Either wire may attach to either terminal. As shown in Figure 1.

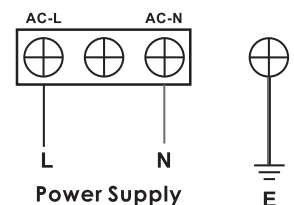

Figure 1

The EPV Series Pump provides power cord that can be plug in to the power source. This is an alternative wire connection for those owners who would like to wire the EPV Series Pump directly to the main power.

Unplug power of the pump. Unscrew the control panel that locates on the top of the electric motor. The power connection locates at the corner where the wire comes out of the box.

As shown in Figure 2, unscrew the pin that fastened the power cord. Take out the power cord with plug and replace with the new one. To fasten the power cord, connect the live wire to the AC-L pin and the neutral wire to the AC-N pin. The ground wire should connect to the ground wire pin.

Connect power to ensure the connections are correct. If not, repeat the steps above and check both pin connections.

Recover the control panel and fasten the screw to prevent potential leakage into the control panel.

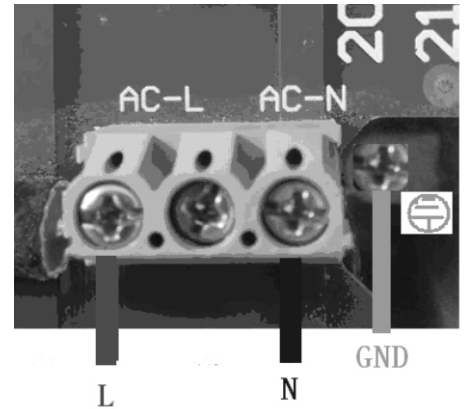

Figure 2

2. User's Guide

2.1 Overview

Functions of the controller is shown below:

- **Time:** Built in time clock.
- **Speed Display:** Expressed in RPM. Shows the operating speed.
- **Preset pump speed:** four optional preset running speeds available.
- **Display:** Time, four preset running speeds, power, Schedule settings and fault codes.

2.2 Controller's outlook display

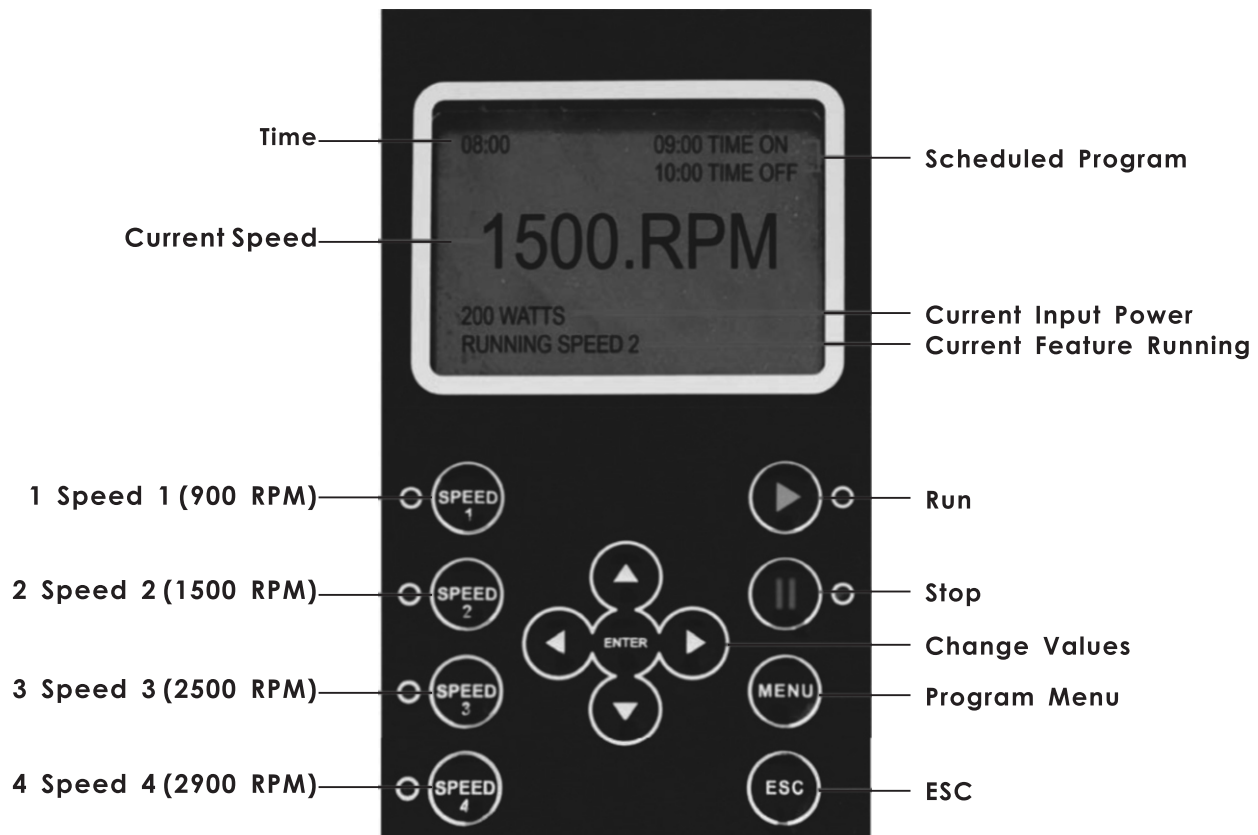

LCD Display backlight will switch off after 60 seconds if no button is pressed. The LCD backlight can be turned on again by pressing any button.

2.3 Controller Display



Turn on interface display

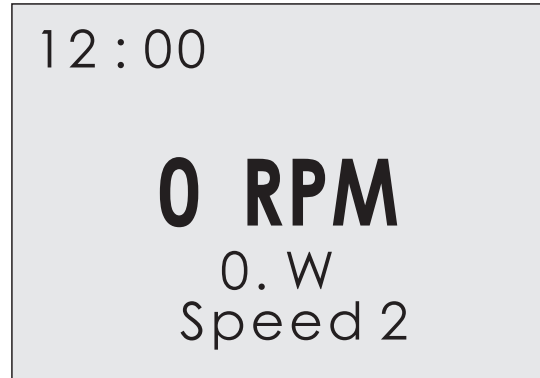

Static interface display



Normal operating interface display

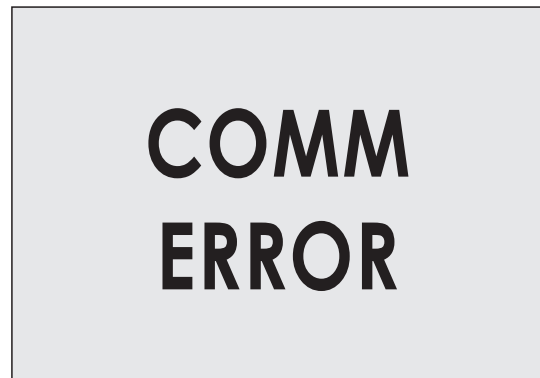

Communication error interface display

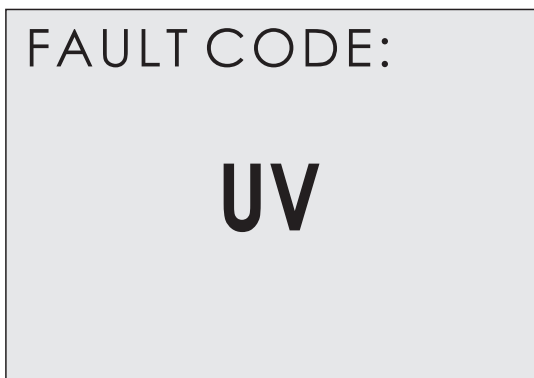



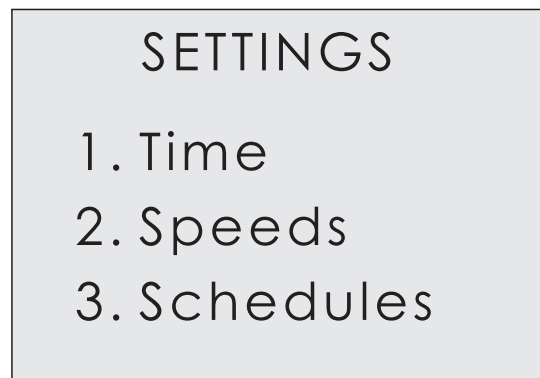









Fault interface display



Parameter setting interface display

Description of Controls

Buttons	Name	Function
	Increase	Press this button to adjust (increase) the setting
	Decrease	Press this button to adjust (decrease) the setting
	Left	Move the cursor keys (select unit, Loop display)
	Right	Move the cursor keys (select unit, Loop display)
	Enter	Entre sub-menu, speed setting adjusting mode or save speed setting
	Speed1	Press this button to select the required preset Motor speed, LED next to the button switches on
	Speed2	Press this button to select the required preset motor speed, LED next to the button switches on
	Speed3	Press this button to select the required preset motor speed, LED next to the button switches on
	Speed4	Press this button to select the required preset motor speed, LED next to the button switches on
	Start	Press this button to start the motor, LED next to the button switches on
	Stop	Press this button to stop the Motor, LED next to the button turns red Drive fault reset key
	Menu	Press this button to enter the parameter adjustment menu when the Motor is not operating
	ESC	Back / Cancel

2.4 Programming

2.4.1 Internal system clock.

An internal system clock is used to maintain programmed operating conditions. If Power Supply is disconnected, the memory & programmed features will be maintained for approximately 7 days. Clock re-set may be required after this time.

2.4.2 Internal Speed (RPM) Adjustments.

There are 4 speed settings available.

To set speed settings, pump must be in the off position.

- Press Menu button.
- Press the buttons marked with an Up or Down arrow to highlight the "2.speeds" on the menu.
- Press Enter to show 1 to 4 speed settings.
- Move buttons marked with an Up or Down arrow to highlight a particular (RPM) speed.
- Press Enter over a highlighted setting, to show the set speed. Adjust that speed by using the Up or Down buttons.
- Press Enter to save that setting or press ESC to escape and not save setting.

2.4.3 Programmed Schedule.

Pump is supplied with a de-fault setting to enable easy installation. This can be altered to suit an individual requirement.

See Flow chart on Page 11.

There are four options available should the customer wish to change the de-fault settings. The same method of programming applies to all 4 programs.

"Function" Schedule setting Enable or Disable.

"Time On" Sets the in-built timer to ON position.

"Time off" Sets the in-built timer to OFF position.

"Speed" Sets the programmed speed (RPM).

Ensure pump is in off position before changing program.

2.4.4 Programming Schedule 1

Function

- To Inspect/change "Function" setting.
- Press Menu, this highlights the settings.
- Using Up/Down buttons go to Schedules.
- Press Enter.
- Move Up/Down buttons and go to Schedules (1 to 4 Listed)
- Press Enter.
- Function title will be highlighted.
- Press enter to change setting from Disable/ Enable using the Up/Down buttons.
- Press Enter to Save OR press ESC to escape and not save.
- Press ESC to exit function setting.

Time On

- To Inspect/change "Time On" settings within Schedules 1
- Move Up/Down buttons to highlight Time on setting.
- Press Enter to show time.
- Highlight Minutes & Hours by using Enter & Left/Right buttons.
- Change time by moving Up/Down buttons.
- Press Enter to Save OR press ESC to escape and not save.
- Press ESC to exit "Time On" setting.

Time Off

To Inspect/change "Time Off" settings within Schedule 1

- Move Up/Down buttons to highlight Time on setting.
- Press Enter to show time.
- Highlight Minutes & Hours by using Enter & Left/Right buttons.
- Change time by moving Up/Down buttons.
- Press Enter to Save OR press ESC to escape and not save.
- Press ESC to exit "Time Off" setting.

Programming Schedules 2, 3 & 4 are the same as programming Schedule 1.

2.4.5 Variable Speed Adjustment.

There are 7 options available.

"Function" Turns the Variable Speed Function on or off.

"Time On" Sets the in-built timer to ON position.

"Time off" Sets the in-built timer to OFF position.

"Min Speed" Sets the minimum speed (RPM) setting.

"Max Speed" Sets the maximum speed (RPM) setting.

"Step" Sets the RPM in "steps" when changing speed settings.

"Rhythm" Sets the time frame for water flow to change.

The "Step" & "Rhythm" settings are particularly useful if a pool feature like a waterfall is installed and you want the water flow to change over time to give a visual effect, for example: a cascading waterfall.

Ensure pump is in off position before changing program.

Press Menu, this highlights the settings.

Using Up/Down buttons go to Variable Speed

Press Enter.

Method of adjustments to above parameters is the same as entering the settings described in Schedule 1.

2.4.6 Language Setting.

- 1) In static condition, press MENU to enter the setting interface;
- 2) Press Increase or Decrease to select "Language";
- 3) Press ENTER to enter the "Language" setting interface, the symbol ">" indicates the current display language;
- 4) Press ENTER again to enter the editing mode, press Increase or Decrease to select the display language that is wished to be set;
- 5) Press ENTER to save the setting, the selected language will be shown on the display interface immediately. press ESC to exit the editing mode if the preset is not wished to be save;
- 6) Press ESC to return.

2.4.7 No Flow Settings.

Note: Only operates when Motor is running above 1800RPM.

There are 3 options available.

"Function"	Will Enable or Disable the No-Flow settings.
"Alarm Time"	Sets the time frame for the No-Flow Protection circuit to operate. Minimum setting is 5 minutes.
"Sensitivity"	Sensitivity of protection system, expressed in %. Minimum setting is 0.01%

Fault Code "NF" will be shown if No Flow Protection System is activated.

Ensure pump is in off position before changing program

Press Menu, this highlights the settings.

Using Up/Down buttons go to Variable Speed

Press Enter.

Method of adjustments to above parameters is the same as entering the settings described in Schedule 1.

2.4.8 Pump Priming Cycle.

There are 3 options available.

"Function"	Pump Priming function enabled or disabled.
"Priming Time"	Time pump is allowed to prime before going to other speed settings.
"Priming Speed"	Set speed for pump to operate during priming cycle.

Ensure pump is in off position before changing program.

Press Menu, this highlights the settings.

Using Up/Down buttons go to Variable Speed

Press Enter.

Method of adjustments to above parameters is the same as entering the settings described Schedule 1.

Pump priming time settings. Minimum time is 1 minute.

Maximum time is 20 minutes.

Default time is 2 minutes.

Pump Priming Speed.

Minimum speed is 2900RPM.

Maximum speed is 3400RPM

Default speed is 2900RPM.

2.5 Factory Default Settings.

This enables you to reset all the default factory settings.

2.5.1 Pump Internal Memory Features.

If the electrical supply to the pump is disconnected, the programmed de-fault settings are maintained for approximately 7 days.

2.5.2 Internal system clock.

An internal system clock is used to maintain programmed operating conditions. If power supply is disconnected, the memory & programmed features will be maintained for approximately 7 days. Clock re-set may be required after this time.

2.5.3 Internal Speed (RPM) Adjustments.

There are 4 speed settings available.

To set speed settings, pump must be in the off position.

- Press Menu button.
- Press the buttons marked with an Up or Down arrow to highlight the "2.speeds" on the menu.
- Press Enter to show 1 to 4 speed settings.
- Move buttons marked with an Up or Down arrow to highlight a particular (RPM) speed.
- Press Enter over a highlighted setting, to show the set speed. Adjust that speed by using the Up or Down buttons.
- Press Enter to save that setting or press ESC to escape and not save setting.

2.5.4 Programming Flow Chart

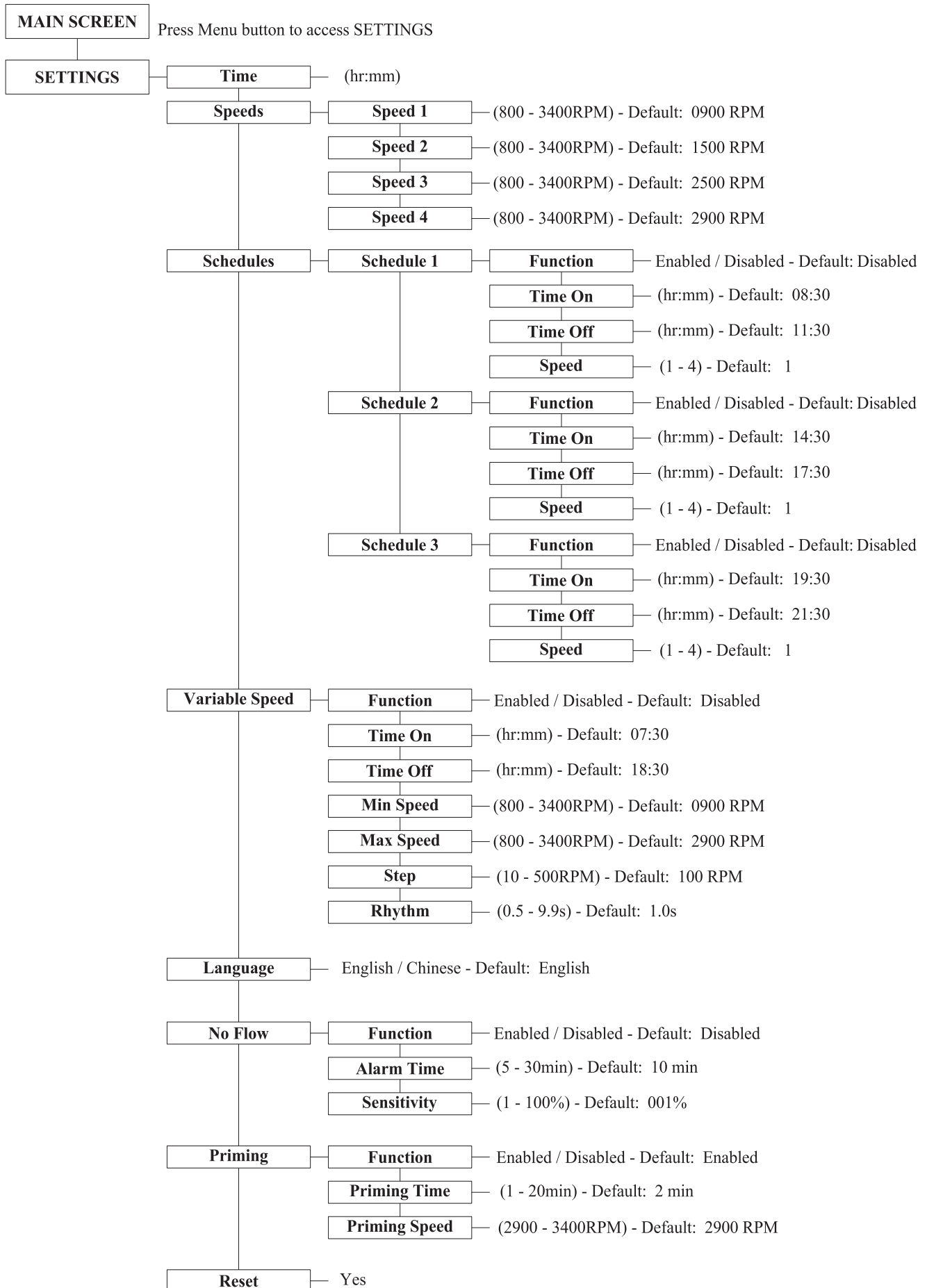

3. Replacement Parts

3.1 Parts Diagram

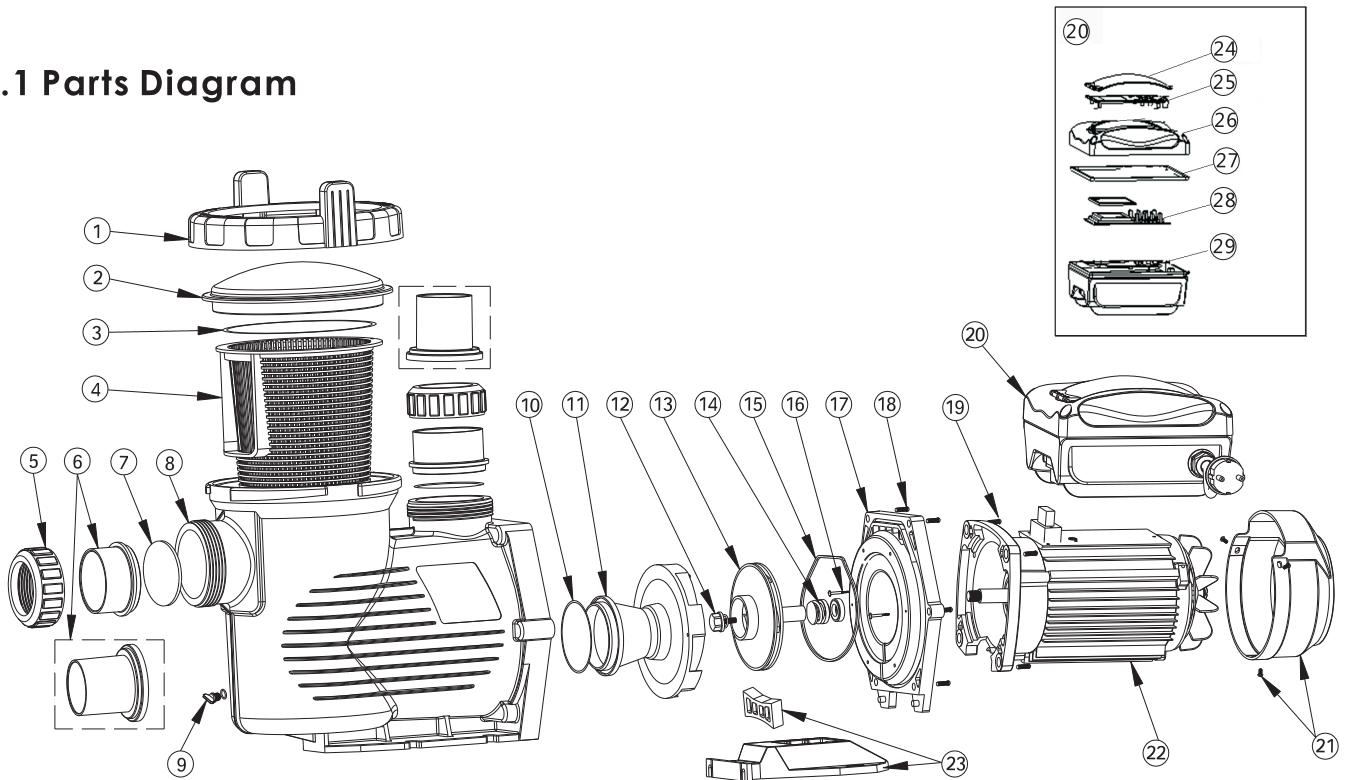

3.2 Parts Listing

Key No.	Part No.	Description	Qty
1	01020016	Nut for Lid	1
2	01041049	Transparent Lid	1
3	02010042	O-Ring for Lid	1
4	01110024	Basket	1
5-7	89020721	2.5" Union With O-ring (E Power)	2
5-7	89020722	2.5" Union / 2" Tale With O-Ring	2
8	01112087	Pump Body	1
9	89021307	Drain Plug With O-Ring	2
10	02010213	O-Ring	1
11	01110025	Diffuser	1
12	89020719	Screw for Impeller with O-Ring	1
13	01311058	Impeller for EPV150	1
13	01311047	Impeller for EPV200	1
13	01400103	Impeller for EPV300	1
14	04015065	3/4" Mechanical Seal	1
15	02010212	O-Ring for Flange	1
16	03011402	M3.5 x 35 Screw	2
17	01020017	Flange	1
18	89020720	M8 x 35 Screw with Washer for Motor	6
19	03011075	M8 x 30 Screw	4
20	89023702	Programmable Controller for EPV150	1
20	89023703	Programmable Controller for EPV200	1
20	89023704	Programmable Controller for EPV300	1

21	01321024	Fan Cover	1
22	04020113	EPV150 TYC-80M Motor	1
22	04020114	EPV200 TYC-80L Motor	1
22	04020115	EPV300 TYC-80XL Motor	1
23	01110026	Base	1
23	02010211	Arch Cushion for Base	1
24	01041054	Transparent Lid for Programmable Controller	1
25	02010302	panel for Programmable Controller	1
26	03039918	Cover for Programmable Controller	1
27	02021080	Cushion for Cover	1
28	04015047	Operation panel (PCB)	1
29	89020802	EPV150 PCB with Shell	1
29	89020803	EPV200 PCB with Shell	1
29	89020804	EPV300 PCB with Shell	1

3.3 Overall Dimension

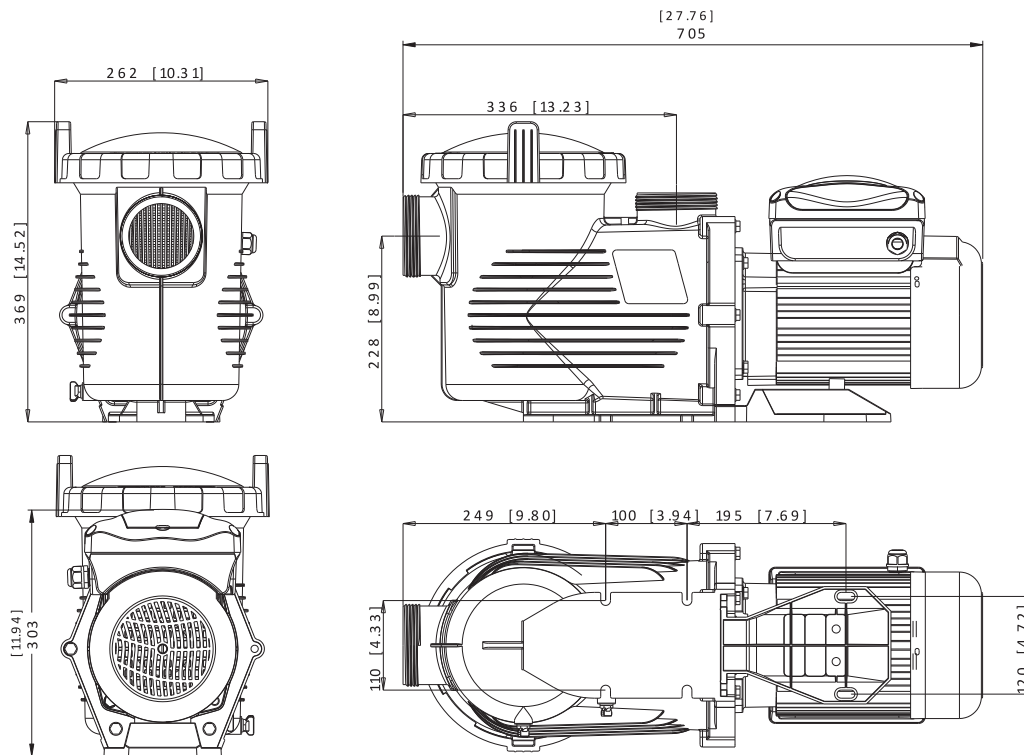

3.4 Product Information

Code 220V-240V 50Hz/60Hz	Model Code	Connection Size		Input Power (Max.)	Horsepower	Weight(kg)
88021107	EPV150	2 inch	2.5 inch	1.50kW	1.5hp	23.00
88021108	EPV200	2 inch	2.5 inch	1.80kW	2.0hp	24.00
88021109	EPV300	2 inch	2.5 inch	2.20kW	3.0hp	25.00

4. Troubleshooting

4.1. Communication error

If there is a communication error inspect the following;

- Ensure the 3-pin plug is making good contact with power point.
- Reset system by turning off Power Supply, leave for 30 seconds then switch on pump again.
- If problem persist after checking the above points, contact your Emaux service agent

4.2. Error Display

When Programmable Controller is not working a fault code will be shown on the controller display.

Error	Info	Cause
OC	Over Current: Driver's output current exceeds the threshold (200%of rated current)	<ul style="list-style-type: none">➤ Driver output failure➤ Drive of IPM module is damaged
OV	Over Voltage: Main circuit DC voltage exceeds the threshold	<ul style="list-style-type: none">➤ Over power of the Power Supply➤ Power-supply voltage exceeds settings
UV	Under Voltage: The main electric current is too low	<ul style="list-style-type: none">➤ Supply voltage fluctuation is too large
OH	Overheating: Heat sink on the Motor overheating.	<ul style="list-style-type: none">➤ Temperature in the surrounded environment is too high
NF	No Water Flow: Absent of water, no water current	<ul style="list-style-type: none">➤ Water level in the pool is too low➤ Not enough water in the basket when starting

4.3. Service Parts.

Refer all service to your local agent or dealer as his knowledge of your equipment makes him the best-qualified source of information. Order all repair parts through your dealer. Please give the following information when ordering repair parts:

- Unit nameplate data or serial number on label.
- Description of part.

4.4. Trouble Shooting Guide.

Pump Does Not Start.

- Check Power Supply is present.
- Check mains cord is plugged in.
- Fuses blown or thermal overload open
- Locked or Jammed Motor shaft - Contact Service Agent.
- Motor windings burned out - Contact Service Agent.
- Disconnected or defective wiring.

Pump Does Not Reach Correct Speed.

- Low Voltage - Contact Service Agent.

Motor Overheating.

- Ensure adequate ventilation.

No or Poor Water Flow.

- Ensure pump is primed.
- Ensure there is no air entering suction side.
- Basket Full of Debris.
- Water Level in pool adequate.

Contact Your Local Service Agent for Further Assistance.

5.Warning

- Pump is to be supplied by an isolating transformer or supplied through a residual current device (RCD) having a rated residual operating current not exceeding 30 mA.
- If the supply cord is damaged, it must be replaced by the manufacturer or its service agent or a similarly qualified person in order to avoid a hazard.
- This appliance can be used by children aged from 8 years and above and persons with reduced physical, sensory or mental capabilities or lack of experience and knowledge if they have been given supervision or instruction concerning use of the appliance in a safe way and understand the hazards involved. Children shall not play with the appliance. Cleaning and user maintenance shall not be made by children without supervision.

Correct Disposal of this Product



This marking indicates that this product should not be disposed with other household wastes throughout the EU. To prevent possible harm to the environment or human health from uncontrolled waste disposal, recycle it responsibly to promote the sustainable reuse of material resources. To return your used device, please use the return and collection systems or contact the retailer where the product was purchased. They can take this product for environmental safe recycling.